

## **12VDC 16PSI Air Pump** **MWA632 Operation Instructions**

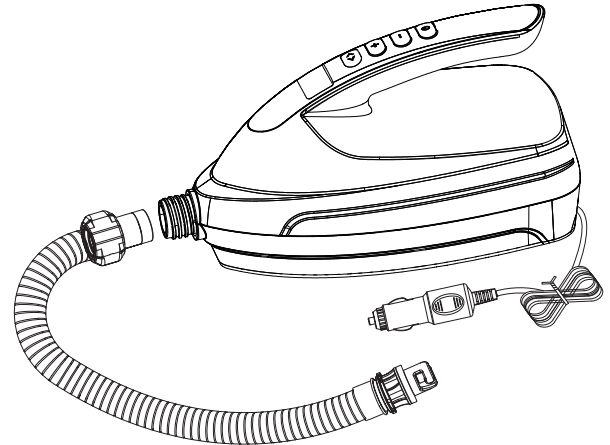

Distributed by:  
Electus Distribution Pty. Ltd.  
320 Victoria Rd, Rydalmere  
NSW 2116 Australia

[www.electusdistribution.com.au](http://www.electusdistribution.com.au)

Made in China

Please read the operation instructions carefully before using this product.  
Please operate in the correct way based on complete understanding.

# 12VDC 16PSI Air Pump

## Contents

I. Product Introduction.....	1
II. List of Accessories.....	1
III. Details of Accessories.....	1
IV. Safety Instructions.....	2
V. Inflation Operation.....	3-4
VI. Precautions.....	4
VII. Fault Handling.....	5
VIII. Maintenance and Storage.....	5
IX. Suggestions.....	5

# 12VDC 16PSI Air Pump

## I. Product Introduction

Thank you for purchasing this product, MWA632 is an intelligent DC electric pump with the preset pressure LCD screen, which can be used for inflatable tent, SUP, etc. Thanks to the intelligent pressure system, for example, if a pressure value is preset, when the pressure reaches the preset pressure value, the pump will automatically stop inflating.

## II. List of Accessories

Please make sure that the following accessories are in the box before using it, if any missing, please contact with the local supplier.

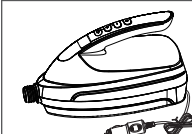
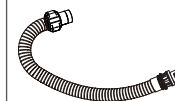
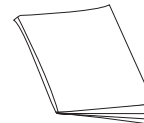
Air pump	Hose	Instruction Book
		

## III. Details of Accessories

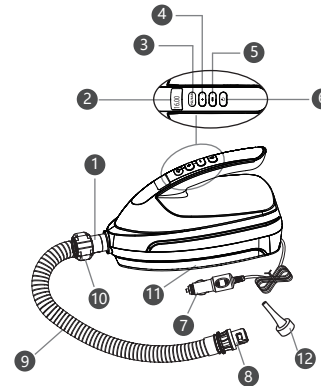

①	Inflation inlet
②	Pressure value LCD screen
③	Pressure unit toggle button
④	Pressurizing button
⑤	Decompressing button
⑥	On/off button
⑦	DC plug
⑧	Air tap
⑨	Hose
⑩	Flexible conduit adaptor
⑪	Air inlet
⑫	Conical adapter



## IV. Safety Instructions

- \* **Warning:** In order to reduce the risk of injury, please keep children away from it. Always supervise children and incapacitated person contacting or using this air pump.
- \* **Warning:** Children shall be kept far away from this product and wire.
- \* **Warning:** This product is not applicable for the person with declining physical strength, sensory ability or mental capacity, the person lack of skill and the mentally retarded person, unless they are under the protection of their guardians, supervised and directed at the same time.
- \* **Warning:** Before moving, maintaining, repairing or adjusting this product, please first pull out the DC plug from the socket.
- \* **Warning:** Please do not bury the wire in the soil, and it shall be place in the safe zone where it won't be damaged by mower or other equipment.
- \* **Warning:** If the power wire is damaged, the power wire must be changed by the manufacturer or its service agent or the similar authorized personnel, in case of any risk.
- \* **Warning:** If you are standing in a place with water or your hands are wet, please don't plug or pull the DC plug.
- \* **Warning:** Before inflating, please pay attention to check the maximum bearable pressure of the inflatable product, because the air bag may be damaged upon exceeding the maximum bearable pressure.
- \* **Warning:** Before using, please check the cigarette lighter socket to make sure that there is no rust or residue inside. The cigarette lighter socket with poor electric conduction may cause overheating of the product or power source, which will damage the product.
- \* **Warning:** The purpose of using this product is limited to the description in the instruction book.
- \* **Warning:** Before using, please check the cigarette lighter socket to make sure that there is no rust or residue inside. The cigarette lighter socket with poor electric conduction may cause overheating of the product or power source, which will damage the product.



## V. Inflation Operation

- \* Connect the end with Flexible conduit adaptor of the hose with the air pump inflation inlet (1), and twist clockwise to tighten it, as Figure 1.
- \* Install the other end of the hose into the supporting air tap of the air bag (step① in Figure 2), and twist clockwise to tighten it, and then insert the inflation valve of the air bag and twist clockwise to fix it (step② in Figure 2).
- \* Plug the DC plug into the 12V DC socket.
- \* Press the pressure unit toggle button (PSI/BAR) to select the unit you need.
- \* Press the pressurizing button (+) or decompressing button (-) to set the pressure value you need, with the range of the pressure value from 0 to 16PSI, (1PSI=0.0689BAR)
- \* After finishing the above steps, press the power switch button (⏻) to start to inflate.
- \* During the inflating process, you can press the pressurizing button (+) or decompressing button (-) to increase or reduce the pressure value, press the pressure unit toggle button (PSI/BAR) to switch the unit, and press the On/Off button (⏻) to stop.

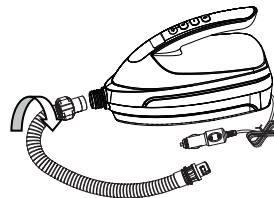

( Figure 1 )

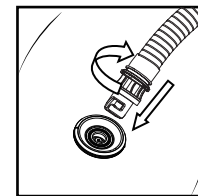

( Figure 2 )

- \* When the pressure reaches the set value, the air pump will stop working automatically.
- \* After completing the inflation, pull out the DC plug from the 12V DC socket.
- \* After pulling out the DC plug, please take down the hose from the air pump and air bag and store it.

- \* Notice: The factory set pressure value of the air pump is 10PSI (10PSI=0.689BAR), and at the time of the secondary use, the set pressure value for the last time use will be displayed by default.
- \* Notice: After powered on, if there is no operation within 2 minutes, the air pump will enter standby mode, and the machine can be initiated by pressing the power switch button (⊖).

## VI. Precautions

- \* The applied power source must be the 12V DC power source (as Figure 3).
- \* Don't block the air inlet (10) at the bottom of the air pump, and guarantee air inlet (10) to be always unblocked.
- \* Observe the local waste treatment provisions, and it is not allowed to throw the air pump away randomly.
- \* Don't use this product when the hose is damaged, and please change the hose immediately.
- \* Don't pull out the hose when inflating, because that the high pressure may hurt the physical body.
- \* Don't make the air pump work for more than 15 minutes, because that motor overheating may cause internal damage; and the air pump shall be fully cooled for 30 minutes after continuously working up to 15 minutes.
- \* Please don't use this air pump if any part is damaged, and please contact with the professional personnel to repair it.
- \* This product shall not be exposed to the rain or immersed in water.
- \* In order to prevent risk, the inflation inlet shall not be forward to face or body.
- \* Please don't not leave while inflating.
- \* Please start the car when using the product, in case of unnecessary damage.

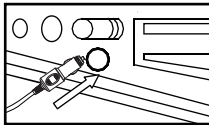

( Figure 3 )

## VII. Fault Handling

Fault	Inspection	Solution
The air pump cannot be started normally.	<ol style="list-style-type: none"> <li>1. The power source is not plugged properly.</li> <li>2. The fuse in DC plug (7) is burnt out.</li> <li>3. Overheating or overload causes motor stop.</li> </ol>	<ol style="list-style-type: none"> <li>1. Make sure that the power wire is plugged in the 12V DC socket.</li> <li>2. Change the fuse.</li> <li>3. Cool the motor and restart it.</li> <li>4. If the problem cannot be solved, please contact with the manufacturer or its service agent or the similar authorized personnel.</li> </ol>
Slow or abnormal inflation.	<ol style="list-style-type: none"> <li>1. Check whether the hose is blocked or cracked.</li> <li>2. The joint between the hose and air pump or air bag is not installed properly.</li> </ol>	<ol style="list-style-type: none"> <li>1. Change the hose or make it unblocked, and check whether the hose is cracked.</li> <li>2. Reinstall the hose.</li> <li>3. If the problem cannot be solved, please contact with the manufacturer or its service agent or the similar authorized personnel.</li> </ol>

## VIII. Maintenance and Storage

- \* After using, or if you want to move, maintain or adjust the product, please first pull out the DC plug from the socket.
- \* when it is idle, it shall be properly stored after being fully cooled.
- \* It shall not be exposed to the rain or immersed in water.
- \* Please store it in the dry and ventilated place.

## IX. Suggestions

The warranty period of this product is one year, and it is suggested to use the original accessories. For any fault not caused by using the original accessories, it shall be out of the warranty scope.